

Bafflelar

PANEL BAFFLELAR

FeltBi[®]



Akustik Baffle

FeltBi Baffle ürünleri, tavana zarif bir şekilde asılırlar. En yüksek kalitede ses emilimini sağlayan , projenize göre özelleştirilebilen, dilediğiniz ölçü ve kalınlıkta, istediğiniz renkte üretilmektedir. Akustik Baffle ürünlerimizi yapmak için Polyester Elyaf (PET) Keçe kullanıyoruz. PET Keçe, mükemmel akustik performans ve dayanıklılık gösteren yumuşak ama güçlü bir malzemedir. Sağlıklıdır, kokusuzdur. Küf tutmaz. Yanıcı malzeme değildir. Bakımı kolaydır, ömrü uzundur. Bu nedenle çok uzun süre kullanma özelliğine sahiptir. Tavana gerekli sayıda askı çubukları ile asılır. Yüksekliği istediğiniz gibi ayarlayabilirsiniz. Feltbi Keçe baffle ürünler mimar ve tasarımcıların estetik vizyonuna uygun olarak çeşitli şekil ve renklerde tasarlanır. Değişik ve fonksiyonel mekanlar yaratılmasına yardımcı olur.

Tasarım ve proje ekibimiz proje bitimine kadar sizinle birlikte çalışacak, teslimat ve kurulum ve sonrası içinde sizlere destek vermeye devam edecektir.

FeltBi Akustik Baffle ürünlerinin yüksek ses emilimi özelliği ile Mekanlar Şimdi Çok Akustik!



Baffle Panel Teknik Özellikleri

FeltBi Polyester Elyaf Keçe
1. Katman - Renk ve Doku

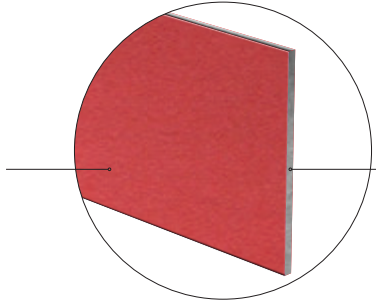

FeltBi Sert Keçe
Temel Katman - Akustik özellik

Keçe Panel Katman Kaplama Çeşitleri

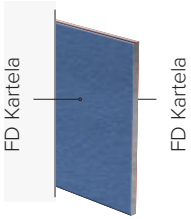

Bakınız sayfa 27



Bakınız sayfa 30

Daha fazla renk seçeneğine ihtiyacınız varsa ve özgün bir tasarım oluşturmak istiyorsanız, FD kartela sizin için daha iyi bir seçim olabilir.

Daha sade ve minimalist bir görünüm istiyorsanız veya renklerin birbiriyle uyumundan emin olmak istiyorsanız,

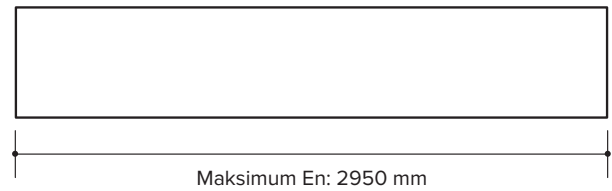
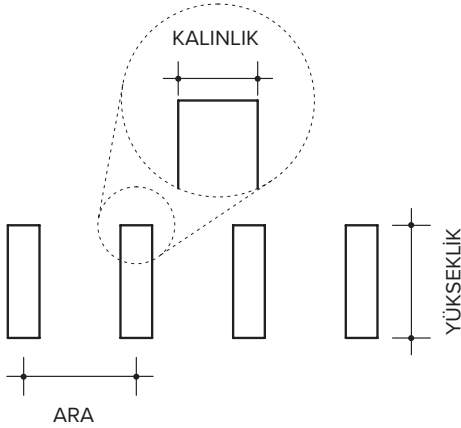

Kalınlık (mm)	Yükseklik (mm)	Ara (mm)
12	100	100
15	150	150
20	200	200
30	250	250
40	400	
50	500	
	600	

Uzunluk (mm)
2950 maksimum

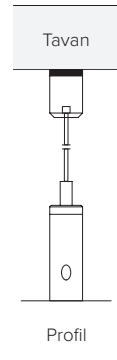

Çelik telli asansörlü
tavan askı aparatı

Akustik Panel Baffle Modeller



BFL-P01
Sayfa 34



BFL-P02
Sayfa 36



BFL-P03
Sayfa 38



BFL-P04
Sayfa 40



BFL-P05
Sayfa 42



BFL-P06
Sayfa 44



BFL-P07
Sayfa 46

Akustik Baffles - BFL-PO1

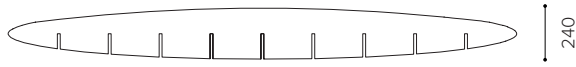

Akustik Baffles - BFL-PO2

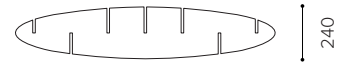

Akustik Baffles - BFL-PO3

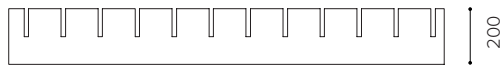

Akustik Baffles - BFL-PO4

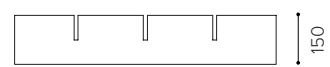

Akustik Baffles - BFL-PO5



Akustik Baffles - BFL-PO6



Akustik Baffles - BFL-PO7

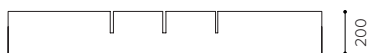

FeltBi Panel Baffle | BFL-P01



Özellikler

Malzeme:	Polyester Elyaf Keçe
Akustik özellikler:	NRC: 0,40-0,90
Yangın sınıfı:	B-s1, d0
Renk:	FD Kartela (Bakınız sayfa 27), Klasik Kartela (Bakınız sayfa 30), KD Kartela (Bakınız sayfa 30)
Kurulum:	Çelik telli asansörlü tavan askı aparatı
Bakım:	Elektrik süpürgesi ile düşük devirde ağır baskı uygulanmadan dış yüzey temizliği yapılabilir. Nemli bir bezle hafifçe silinerek dış yüzey temizliği yapılabilir.

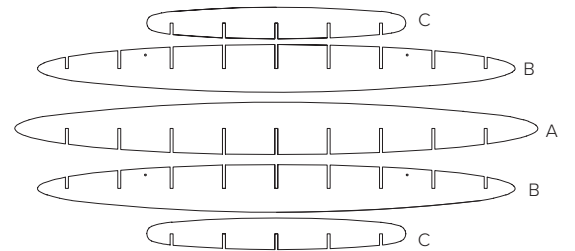
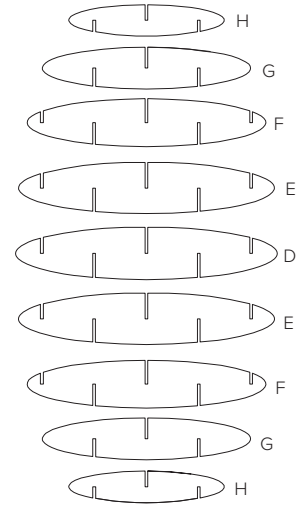
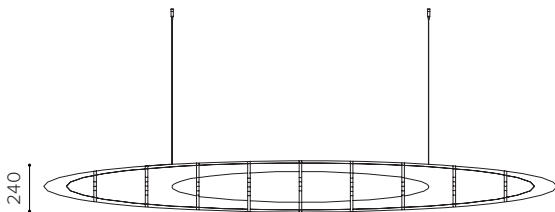
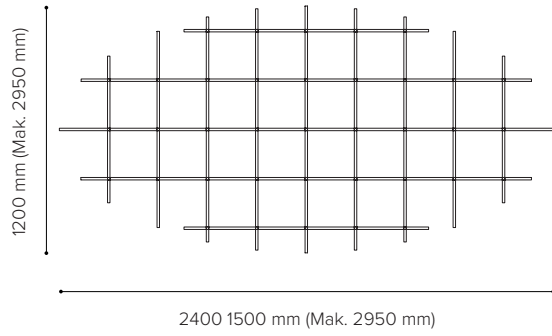

FeltBi Panel Baffle | BFL-P02



Özellikler

Malzeme:	Polyester Elyaf Keçe
Akustik özellikler:	NRC: 0,40-0,90
Yangın sınıfı:	B-s1, d0
Renk:	FD Kartela (Bakınız sayfa 27), Klasik Kartela (Bakınız sayfa 30,) KD Kartela (Bakınız sayfa 30)
Kurulum:	Çelik telli asansörlü tavan askı aparatı
Bakım:	Elektrik süpürgesi ile düşük devirde ağır baskı uygulanmadan dış yüzey temizliği yapılabilir. Nemli bir bezle hafifçe silinerek dış yüzey temizliği yapılabilir.

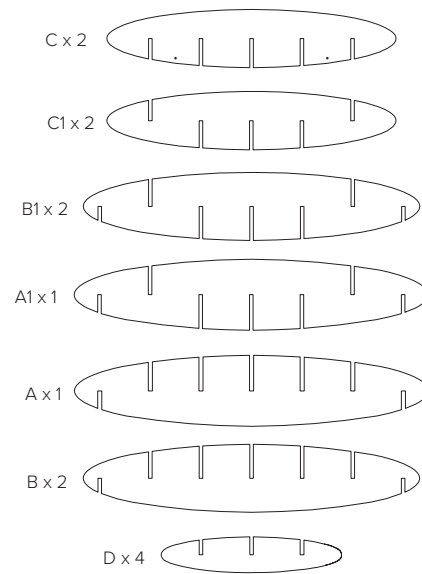
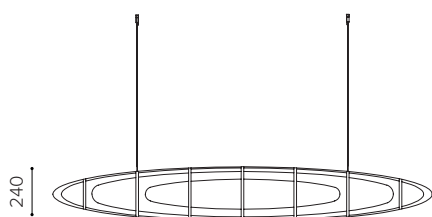
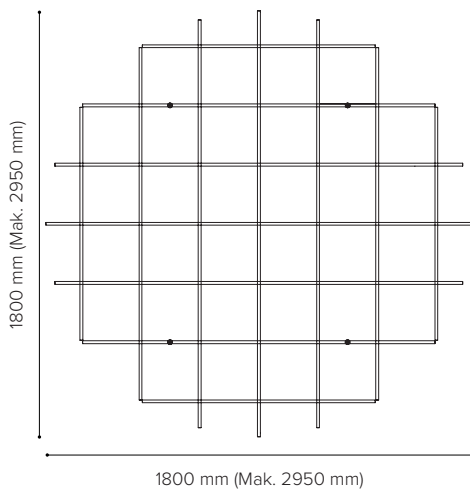

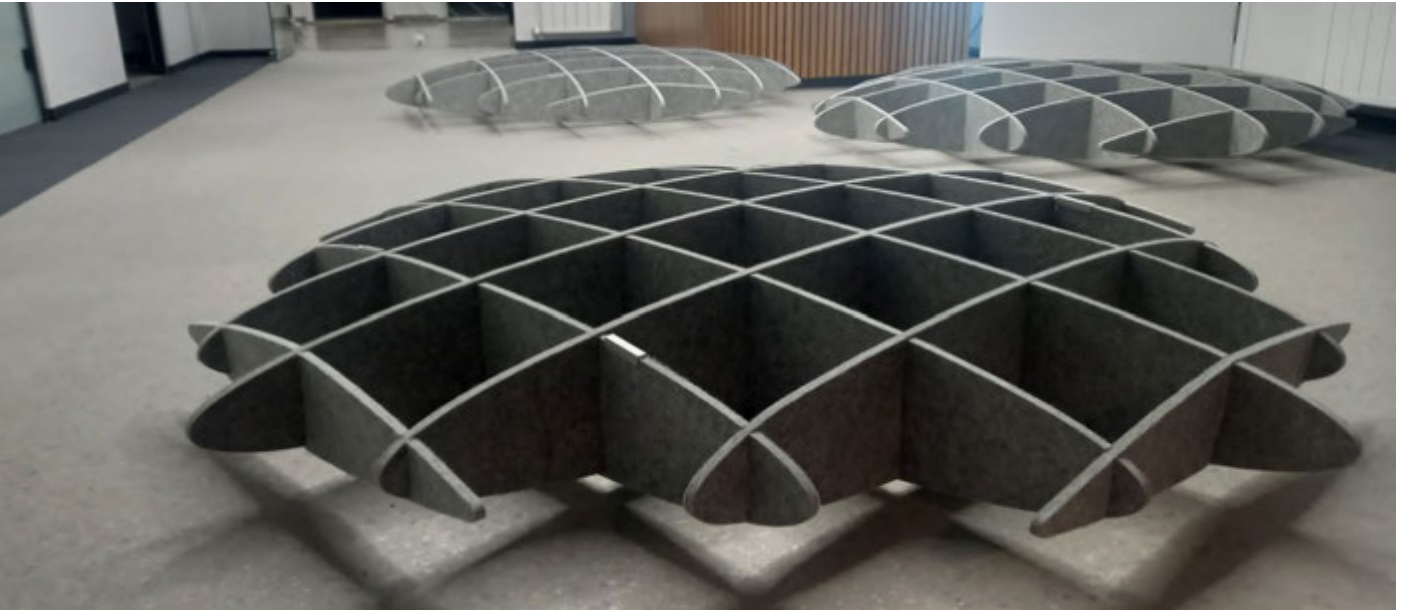

FeltBi Panel Baffle | BFL-P03

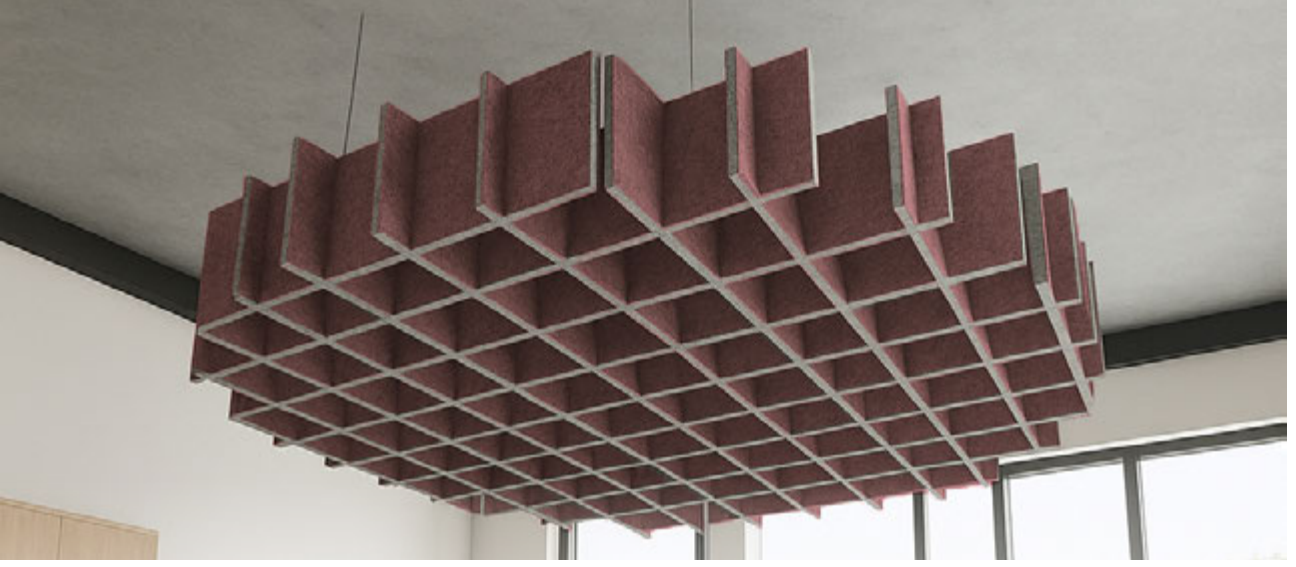

Özellikler

Malzeme:	Polyester Elyaf Keçe
Akustik özellikler:	NRC: 0,40-0,90
Yangın sınıfı:	B-s1, d0
Renk:	FD Kartela (Bakınız sayfa 27), Klasik Kartela (Bakınız sayfa 30), KD Kartela (Bakınız sayfa 30)
Kurulum:	Çelik telli asansörlü tavan askı aparatı
Bakım:	Elektrik süpürgesi ile düşük devirde ağır baskı uygulanmadan dış yüzey temizliği yapılabilir. Nemli bir bezle hafifçe silinerek dış yüzey temizliği yapılabilir.

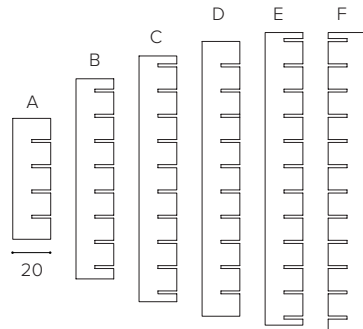
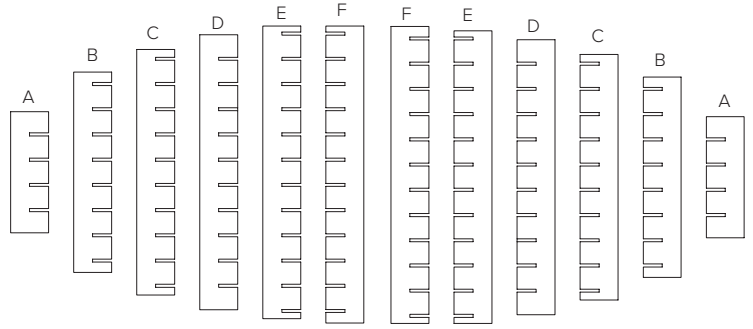
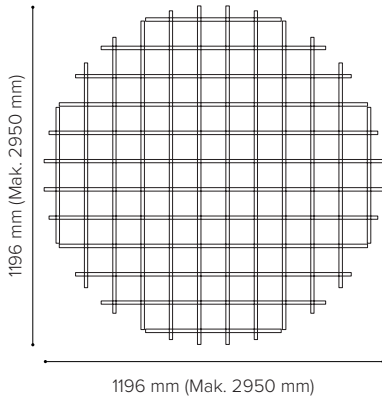

FeltBi Panel Baffle | BFL-P04



Özellikler

Malzeme:	Polyester Elyaf Keçe
Akustik özellikler:	NRC: 0,40-0,90
Yangın sınıfı:	B-s1, d0
Renk:	FD Kartela (Bakınız sayfa 27), Klasik Kartela (Bakınız sayfa 30), KD Kartela (Bakınız sayfa 30)
Kurulum:	Çelik telli asansörlü tavan askı aparatı
Bakım:	Elektrik süpürgesi ile düşük devirde ağır baskı uygulanmadan dış yüzey temizliği yapılabilir. Nemli bir bezle hafifçe silinerek dış yüzey temizliği yapılabilir.

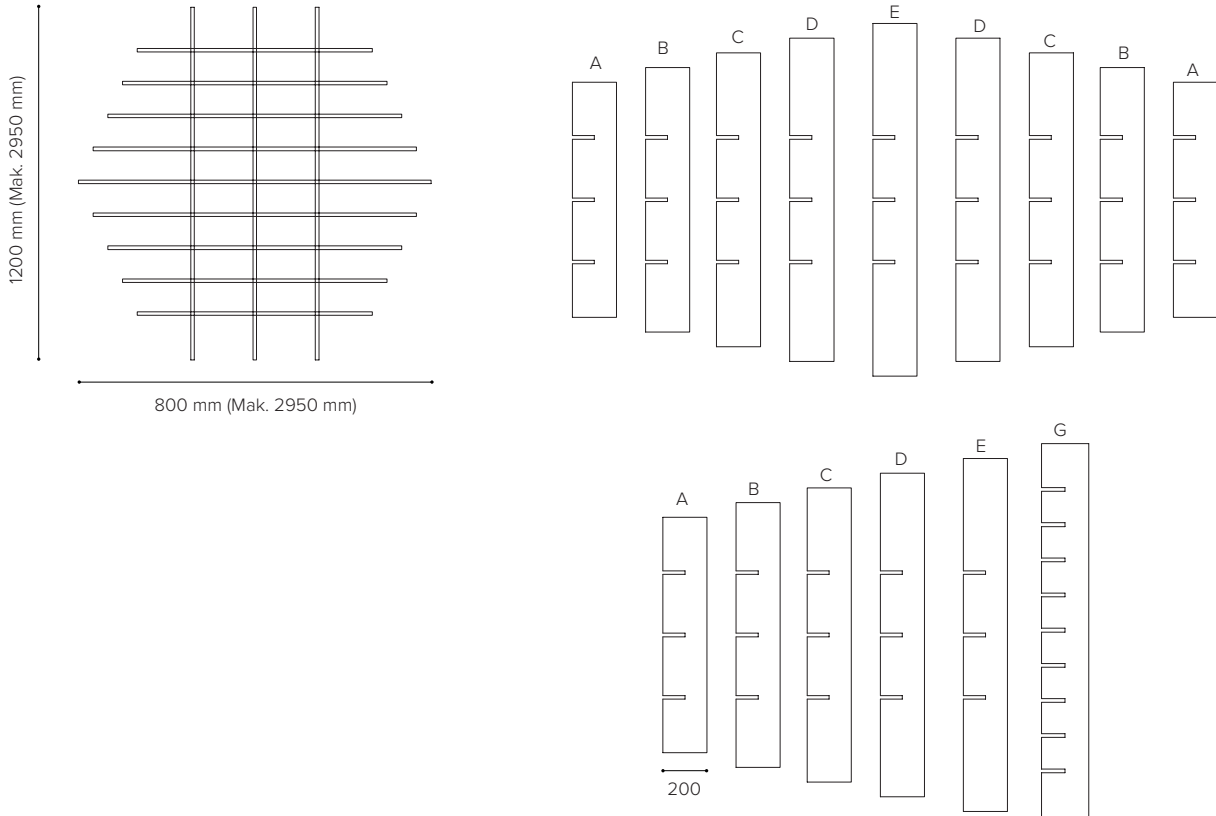



FeltBi Panel Baffle | BFL-P05



Özellikler

Malzeme:	Polyester Elyaf Keçe
Akustik özellikler:	NRC: 0,40-0,90
Yangın sınıfı:	B-s1, d0
Renk:	FD Kartela (Bakınız sayfa 27), Klasik Kartela (Bakınız sayfa 30), KD Kartela (Bakınız sayfa 30)
Kurulum:	Çelik telli asansörlü tavan askı aparatı
Bakım:	Elektrik süpürgesi ile düşük devirde ağır baskı uygulanmadan dış yüzey temizliği yapılabilir. Nemli bir bezle hafifçe silinerek dış yüzey temizliği yapılabilir.

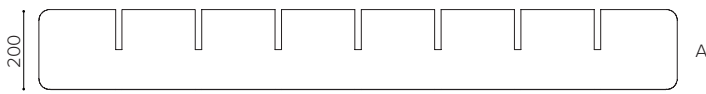
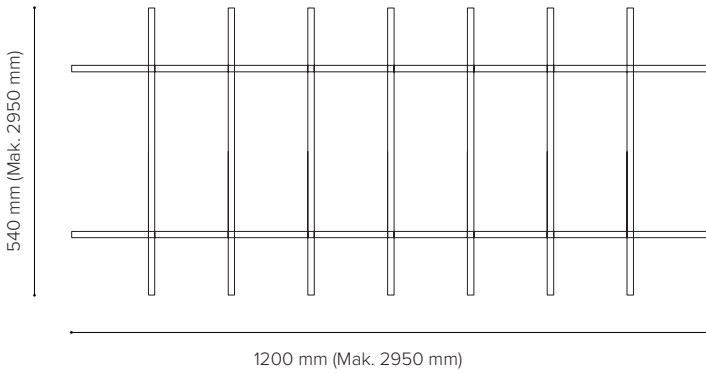

FeltBi Panel Baffle | BFL-P06



Özellikler

Malzeme:	Polyester Elyaf Keçe
Akustik özellikler:	NRC: 0,40-0,90
Yangın sınıfı:	B-s1, d0
Renk:	FD Kartela (Bakınız sayfa 27), Klasik Kartela (Bakınız sayfa 30), KD Kartela (Bakınız sayfa 30)
Kurulum:	Çelik telli asansörlü tavan askı aparatı
Bakım:	Elektrik süpürgesi ile düşük devirde ağır baskı uygulanmadan dış yüzey temizliği yapılabilir. Nemli bir bezle hafifçe silinerek dış yüzey temizliği yapılabilir.

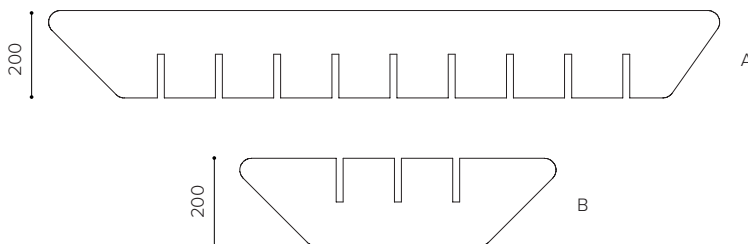
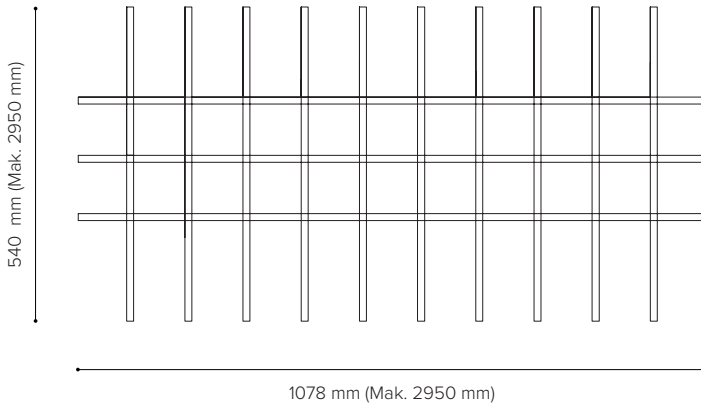



FeltBi Panel Baffle | BFL-P07

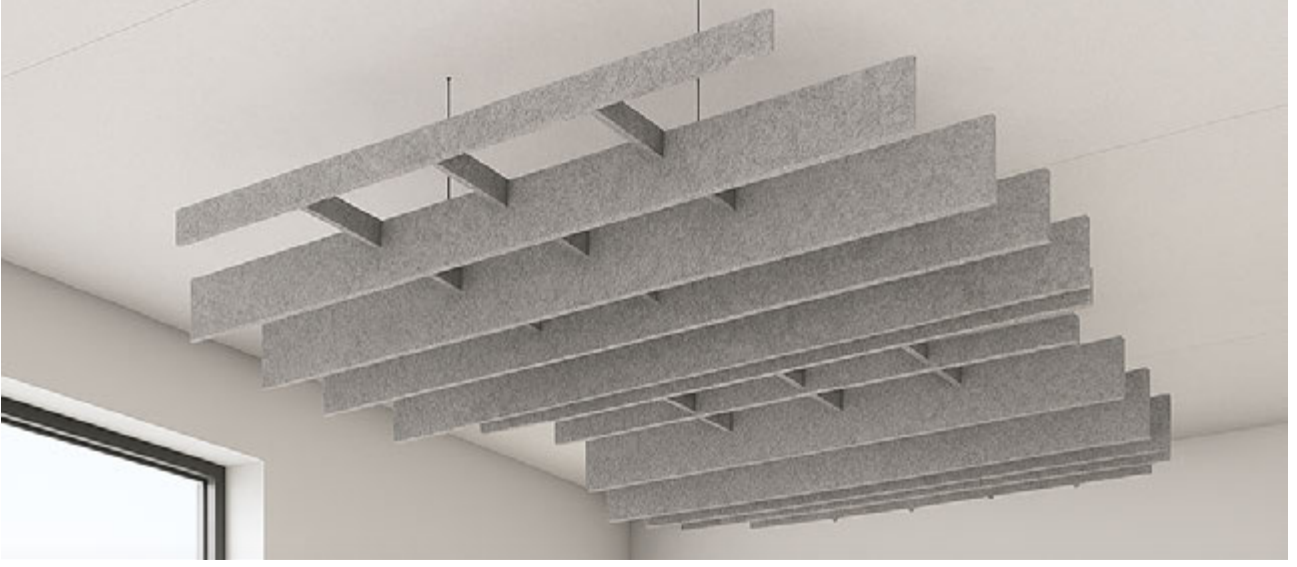

Özellikler

Malzeme:	Polyester Elyaf Keçe
Akustik özellikler:	NRC: 0,40-0,90
Yangın sınıfı:	B-s1, d0
Renk:	FD Kartela (Bakınız sayfa 27), Klasik Kartela (Bakınız sayfa 30), KD Kartela (Bakınız sayfa 30)
Kurulum:	Çelik telli asansörlü tavan askı aparatı
Bakım:	Elektrik süpürgesi ile düşük devirde ağır baskı uygulanmadan dış yüzey temizliği yapılabilir. Nemli bir bezle hafifçe silinerek dış yüzey temizliği yapılabilir.

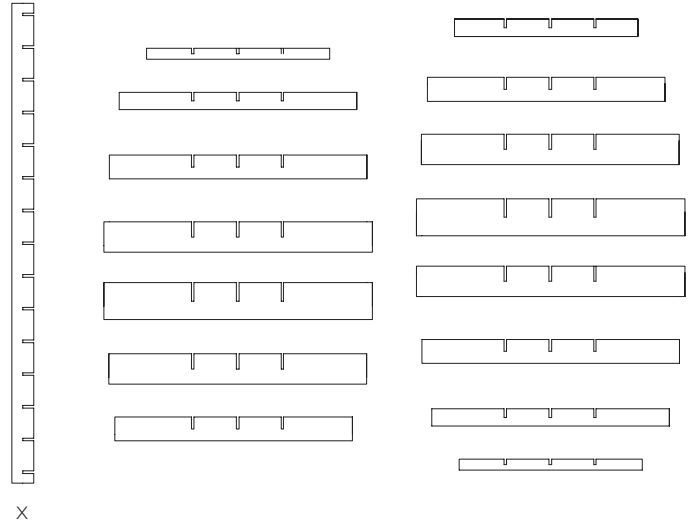
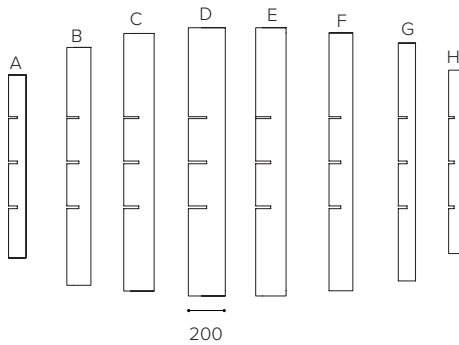
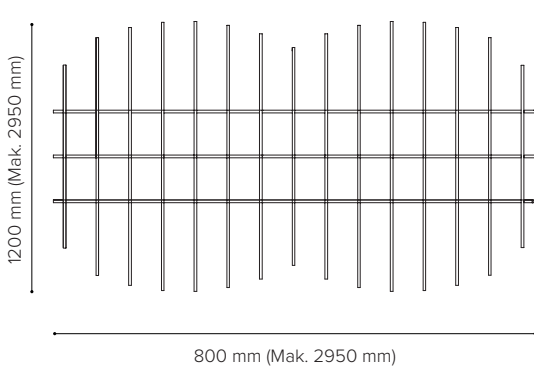

FD KARTELA KEÇE KUMAŞ RENKLERİ

							
FD101	FD102	FD103	FD104	FD105	FD106	FD107	FD108
							
FD109	FD110	FD111	FD112	FD113	FD114	FD115	FD116
							
FD117	FD118	FD119	FD120	FD121	FD122	FD123	FD124
							
FD125	FD126	FD127	FD128	FD129	FD130	FD131	FD132
							
FD133	FD134	FD135	FD136	FD137	FD138	FD139	FD140
							
FD141	FD142	FD143	FD144	FD145	FD146	FD147	FD148
							
FD149	FD150	FD151	FD152	FD153	FD154	FD155	FD156
							
FD157	FD158	FD159	FD160	FD161	FD162	FD163	FD164
							
FD165	FD166	FD167	FD168	FD169	FD170	FD171	FD172

FD KARTELA KEÇE KUMAŞ RENKLERİ

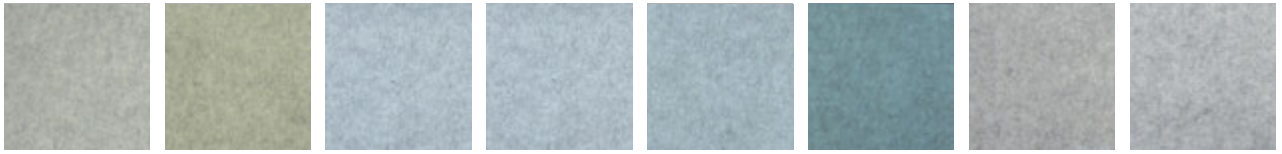

FD173

FD174

FD175

FD176

FD177

FD178

FD179

FD180



FD181

FD182

FD183

FD184

FD185

FD186

FD187

FD188



FD189

FD190

FD191

FD192

FD193

FD194

FD195

FD196



FD197

FD198

FD199

FD200

FD201

FD202

FD203

FD204

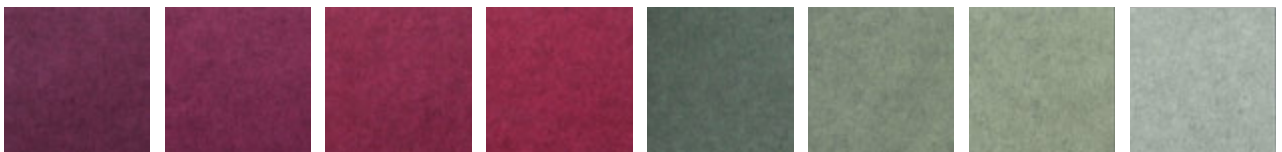

FD205

FD206

FD207

FD208

FD209

FD210

FD211

FD212



FD213

FD214

FD215

FD216

FD217

FD218

FD219

FD220



FD221

FD222

FD223

FD224

FD225

FD226

FD227

FD228



FD229

FD230

FD231

FD232

FD233

FD234

FD235

FD236



FD237

FD238

FD239

FD240

FD241

FD242

FD243

FD244

FD KARTELA KEÇE KUMAŞ RENKLERİ

							
FD245	FD246	FD247	FD248	FD249	FD250	FD251	FD252
							
FD253	FD254	FD255	FD256	FD257	FD258	FD259	FD260
							
FD261	FD262	FD263	FD264	FD265	FD266	FD267	FD268
							
FD269	FD270	FD271	FD272	FD273	FD274	FD275	FD276
							
FD277	FD278	FD279	FD280	FD281	FD282	FD283	FD284
							
FD285	FD286	FD287	FD288	FD289	FD290	FD291	FD292
							
FD293	FD294	FD295	FD296	FD297	FD298	FD299	FD300
							
FD301	FD302	FD303	FD304	FD305	FD306	FD307	FD308
							
FD309	FD310	FD311	FD312	FD313	FD314	FD315	FD316

KLASİK KEÇE RENKLERİ

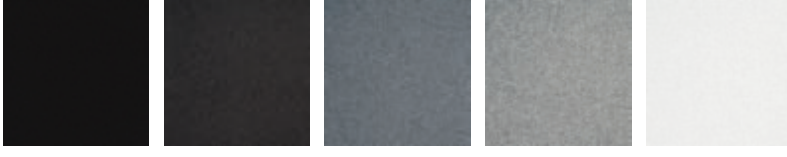

KK101

KK102

KK103

KK104

KK105

KD KEÇE RENKLERİ



KD101

KD102

KD103

KD104

KD105

KD106

KD107

KD108

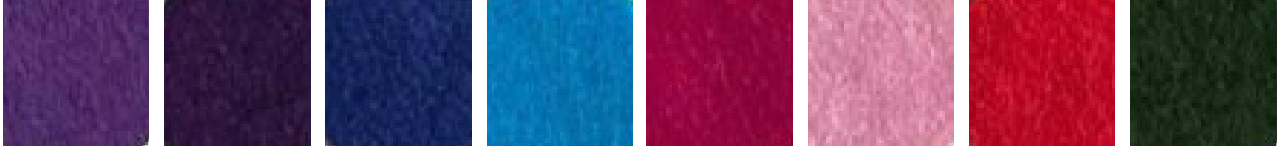

KD109

KD110

KD111

KD112

KD113

KD114

KD115

KD116



KD117

KD118

KD119

FeltBi®

SHOWROOM / MERKEZ OFİS:

Gülbahar Mah. Cemal Sururi Sk. Halim Meriç İş Merkezi
Kat: 9 No: 43, 34394, Şişli/İstanbul/Türkiye

ÜRETİM:

Bozkurt Mah. Dolapdere Cad. No: 167,
34375, Şişli/İstanbul/Türkiye

İLETİŞİM:

[+90] 505 366 88 13

info@feltbi.com

feltbi.com

