

FeltBi

AKUSTİK DUVAR PANELLERİ

# Puzzle Series



Ses Yalıtımlı, Keçeden Duvar Panelleri

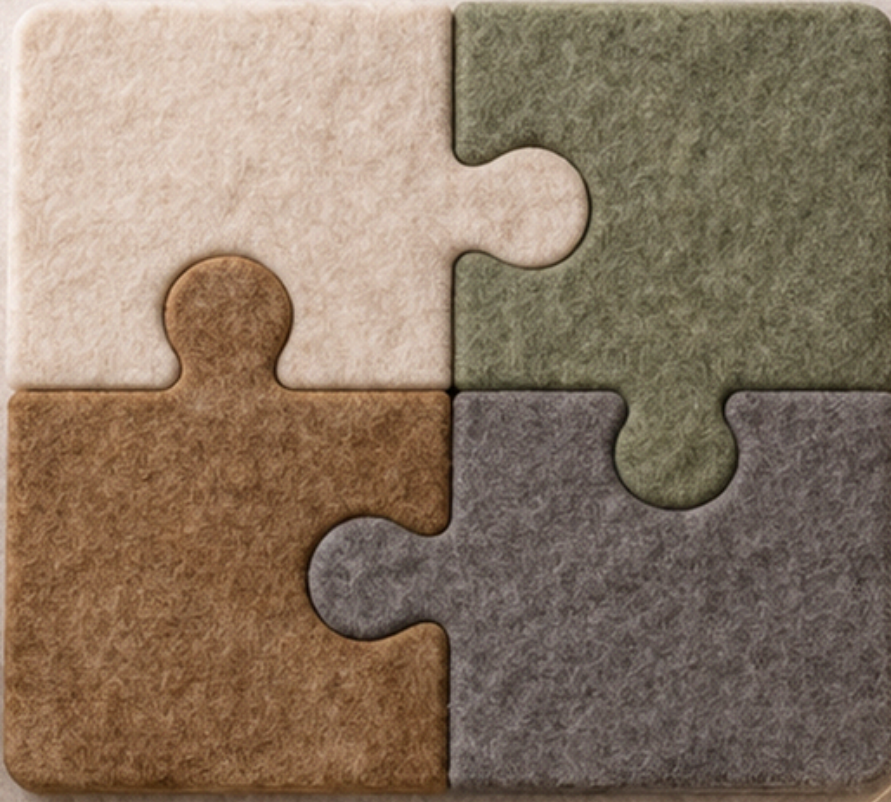

FeltBi

AKUSTİK ÇÖZÜMLERDE UYUM VE ESTETİK

# FELTBI

## Puzzle Serisi Duvar Panelleri

*Sürdürülebilir Tasarım,  
Akustik Konfor*

FeltBi Puzzle Serisi, geri dönüştürülmüş pet şişelerden elde edilen ham keçe malzeme ile üretilmiştir. Doğaya duyarlı üretim anlayışıyla geliştirilen bu paneller, sürdürülebilirliği modern tasarım ile buluşturur.

Modüler yapısı sayesinde farklı kombinasyonlar oluşturulabilir, mekânlara özgün bir karakter kazandırır. Akustik performansı ile ses kontrolü sağlarken, estetik görünümü ile yaşam ve çalışma alanlarını zenginleştirir.

Yüksek yoğunluklu keçe yapısı, yankıyı azaltarak daha konforlu ve dengeli bir ortam oluşturur.

Puzzle formu sayesinde yaratıcı yüzey tasarımlarına imkân tanır.



### Akustik Performans

Ses yalıtımı ve yankı kontrolü sağlar



### %100 Geri Donüştürülmüş Keçe

Pet şişelerden üretilmiş çevre dostu malzeme



### Modüler Tasarım

Farklı kombinasyon ve uygulama özgürlüğü



### Kolay Montaj

Hızlı ve pratik uygulama imkânı



# SORA

## Modüler Panel serisi

Modüler tasarım ile sınırsız kombinasyonlar  
Akustik ve dekoratif yüzey çözümü

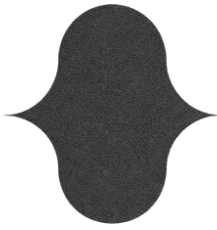
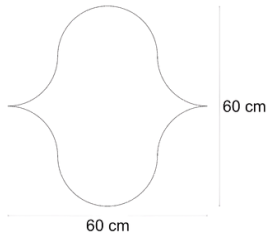

FD-208

Malzeme :100% KEÇE

Kalınlık:6-9-12 mm

Uygulama:Yapıştırma/Modüler montaj

## Renk Koleksiyonu



Siyah Koyu Gri Gri Beyaz Bej



15-14f 6-16b 1-20f 4-14e 3-33c



1-1e 3-23d 4-23e 10-25e 9-21c

# XENON

## Modüler Panel serisi

Modüler tasarım ile sınırsız kombinasyonlar  
Akustik ve dekoratif yüzey çözümü

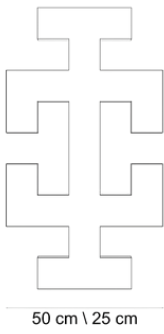
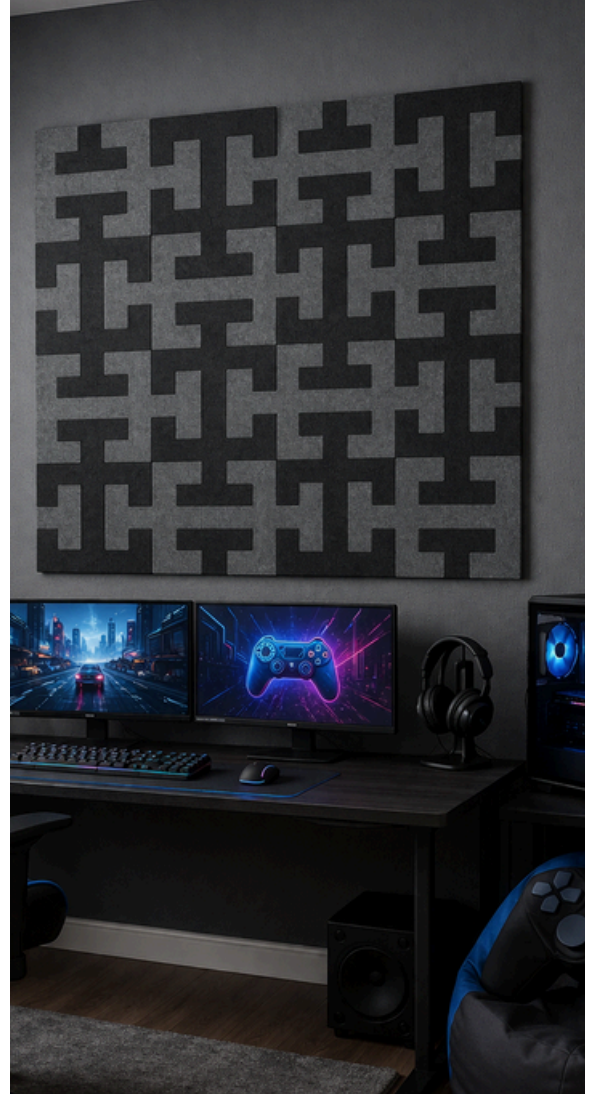

90 cm \ 45 cm

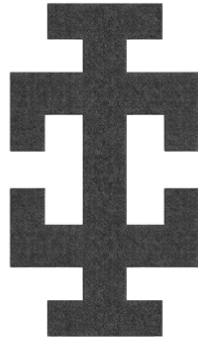

Malzeme :100% KEÇE

Kalınlık:6-9-12 mm

Uygulama:Yapıştırma/Modüler montaj

## Renk Koleksiyonu



Siyah Koyu Gri Gri Beyaz Bej



15-14f 6-16b 1-20f 4-14e 3-33c



1-1e 3-23d 4-23e 10-25e 9-21c

# VETRA

## Modüler Panel serisi

Modüler tasarım ile sınırsız kombinasyonlar  
Akustik ve dekoratif yüzey çözümü

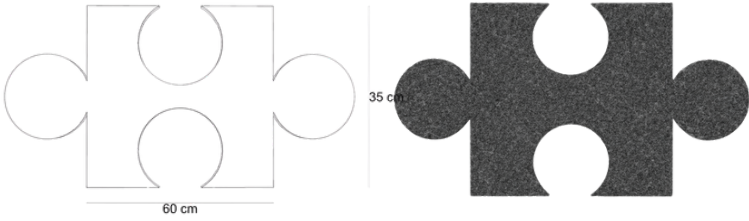

## Renk Koleksiyonu

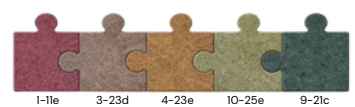
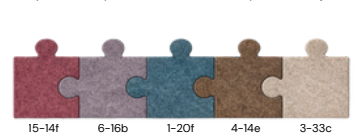

Malzeme :100% KEÇE

Kalınlık:6-9-12 mm

Uygulama:Yapıştırma/Modüler montaj

# NARA

## Modüler Panel serisi

Modüler tasarım ile sınırsız kombinasyonlar  
Akustik ve dekoratif yüzey çözümü

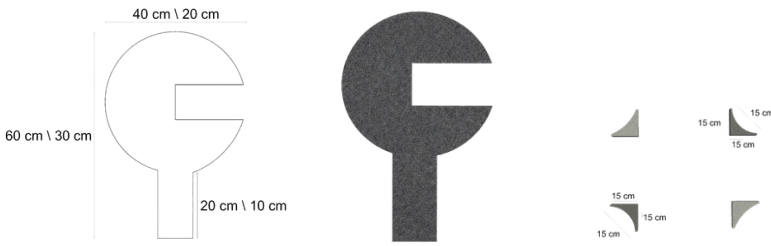

Malzeme :100% KEÇE

Kalınlık:6-9-12 mm

Uygulama:Yapıştırma/Modüler montaj

## Renk Koleksiyonu



Siyah Koyu Gri Gri Beyaz Bej



15-14f 6-16b 1-20f 4-14e 3-33c



1-11e 3-23d 4-23e 10-25e 9-21c

# DOA

## Modüler Panel serisi

Modüler tasarım ile sınırsız kombinasyonlar  
Akustik ve dekoratif yüzey çözümü

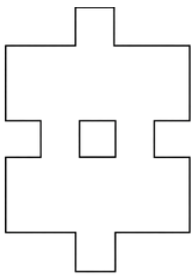
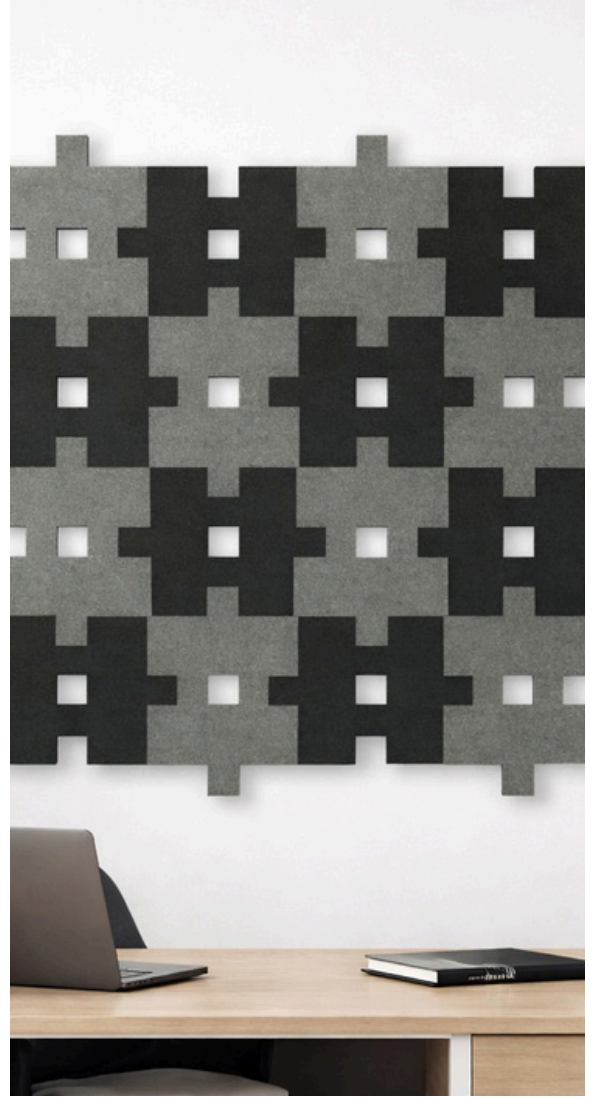

50 cm

70 cm

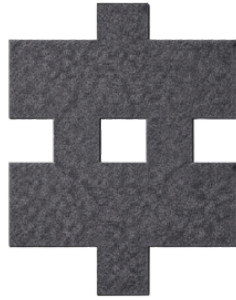

Malzeme :100% KEÇE

Kalınlık:6-9-12 mm

Uygulama:Yapıştırma/Modüler montaj

## Renk Koleksiyonu



Siyah Koyu Gri Gri Beyaz Bej



15-14f 6-16b 1-20f 4-14e 3-33c



1-1e 3-23d 4-23e 10-25e 9-21c

# Modüler Puzzle Paneller-RION





# RION

## Modüler Panel serisi

Modüler tasarım ile sınırsız kombinasyonlar  
Akustik ve dekoratif yüzey çözümü

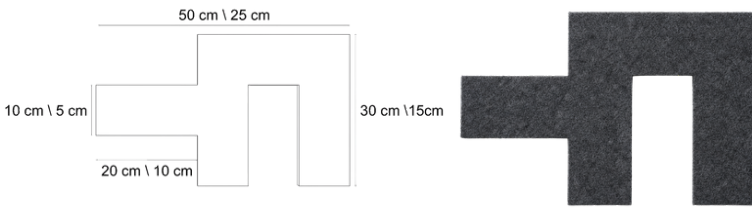

Malzeme :100% KEÇE

Kalınlık:6-9-12 mm

Uygulama:Yapıştırma/Modüler montaj

## Renk Koleksiyonu



Siyah Koyu Gri Gri Beyaz Bej



15-14f 6-16b 1-20f 4-14e 3-33c



1-1e 3-23d 4-23e 10-25e 9-21c

# ARVO

## Modüler Panel serisi

Modüler tasarım ile sınırsız kombinasyonlar  
Akustik ve dekoratif yüzey çözümü

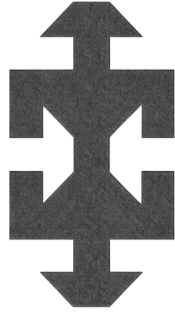
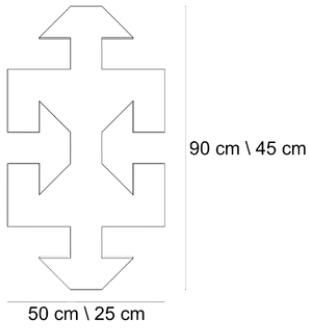

## Renk Koleksiyonu

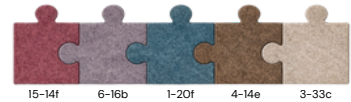

Malzeme :100% KEÇE

Kalınlık:6-9-12 mm

Uygulama:Yapıştırma/Modüler montaj

# TALYA

## Modüler Panel serisi

Modüler tasarım ile sınırsız kombinasyonlar  
Akustik ve dekoratif yüzey çözümü

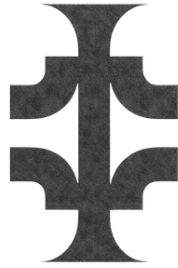
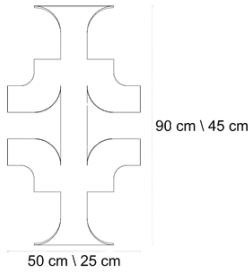

## Renk Koleksiyonu



Siyah Koyu Gri Gri Beyaz Bej



15-14f 6-16b 1-20f 4-14e 3-33c



1-1e 3-23d 4-23e 10-25e 9-21c

Malzeme :100% KEÇE

Kalınlık:6-9-12 mm

Uygulama:Yapıştırma/Modüler montaj



# MERA

## Modüler Panel serisi

Modüler tasarım ile sınırsız kombinasyonlar  
Akustik ve dekoratif yüzey çözümü

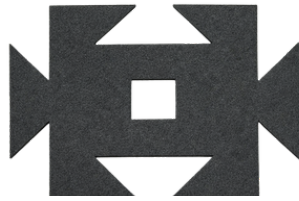
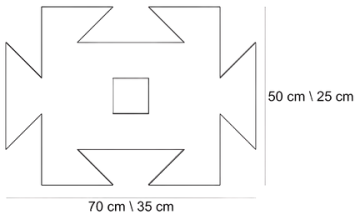

Malzeme :100% KEÇE

Kalınlık:6-9-12 mm

Uygulama:Yapıştırma/Modüler montaj

## Renk Koleksiyonu



Siyah Koyu Gri Gri Beyaz Bej



15-14f 6-16b 1-20f 4-14e 3-33c



1-1e 3-23d 4-23e 10-25e 9-21c

# LONA

## Modüler Panel serisi

Modüler tasarım ile sınırsız kombinasyonlar  
Akustik ve dekoratif yüzey çözümü

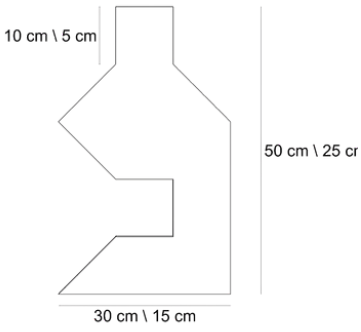

## Renk Koleksiyonu

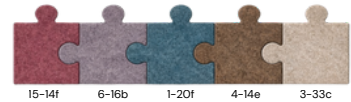

Malzeme :100% KEÇE

Kalınlık:6-9-12 mm

Uygulama:Yapıştırma/Modüler montaj

## Modüler Puzzle Paneller-ZONE



# ZONE

## Modüler Panel serisi

Modüler tasarım ile sınırsız kombinasyonlar  
Akustik ve dekoratif yüzey çözümü

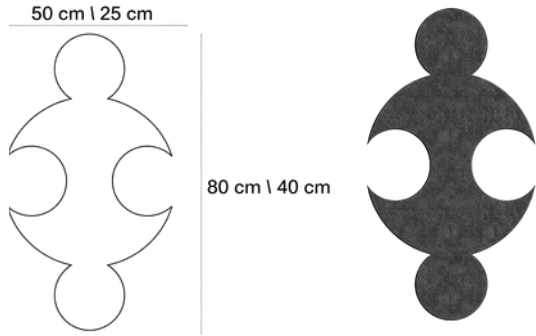

Malzeme :100% KEÇE

Kalınlık:6-9-12 mm

Uygulama:Yapıştırma/Modüler montaj

## Renk Koleksiyonu

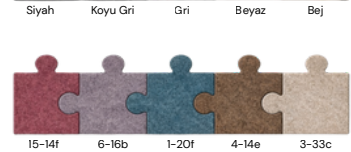

# LUME

## Modüler Panel serisi

Modüler tasarım ile sınırsız kombinasyonlar  
Akustik ve dekoratif yüzey çözümü

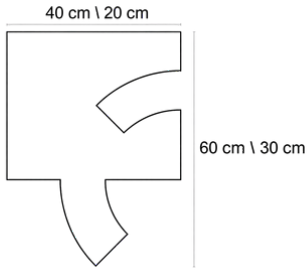

Malzeme :100% KEÇE

Kalınlık:6-9-12 mm

Uygulama:Yapıştırma/Modüler montaj

## Renk Koleksiyonu

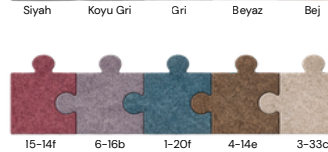

# NARA

## Modüler Panel serisi

Modüler tasarım ile sınırsız kombinasyonlar  
Akustik ve dekoratif yüzey çözümü

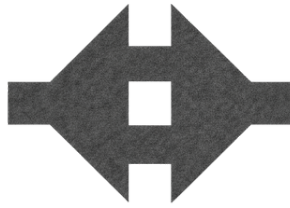
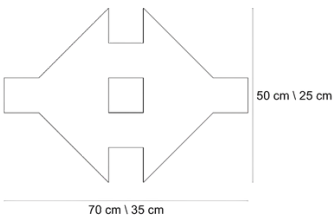

## Renk Koleksiyonu

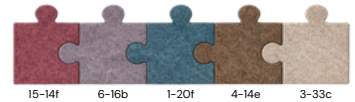

Malzeme :100% KEÇE

Kalınlık:6-9-12 mm

Uygulama:Yapıştırma/Modüler montaj

# PİVOT

## Modüler Panel serisi

Modüler tasarım ile sınırsız kombinasyonlar  
Akustik ve dekoratif yüzey çözümü

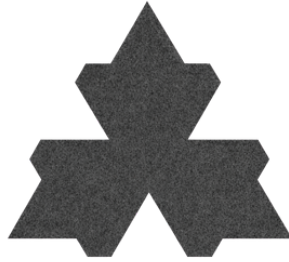
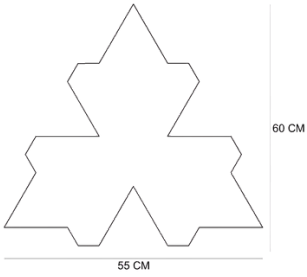

Malzeme :100% KEÇE

Kalınlık:6-9-12 mm

Uygulama:Yapıştırma/Modüler montaj

## Renk Koleksiyonu



Siyah Koyu Gri Gri Beyaz Bej



15-14f 6-16b 1-20f 4-14e 3-33c



1-1e 3-23d 4-23e 10-25e 9-21c

# RİMOR

## Modüler Panel serisi

Modüler tasarım ile sınırsız kombinasyonlar  
Akustik ve dekoratif yüzey çözümü

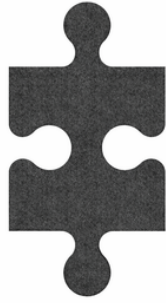
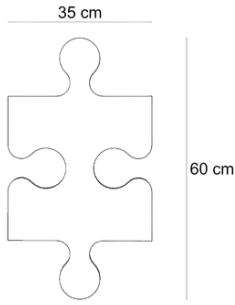

Malzeme :100% KEÇE

Kalınlık:6-9-12 mm

Uygulama:Yapıştırma/Modüler montaj

## Renk Koleksiyonu



Siyah Koyu Gri Gri Beyaz Bej



15-14f 6-16b 1-20f 4-14e 3-33c



1-1e 3-23d 4-23e 10-25e 9-21c

# Modüler Puzzle Paneller-DRIVE



# DRIVE

## Modüler Panel serisi

Modüler tasarım ile sınırsız kombinasyonlar  
Akustik ve dekoratif yüzey çözümü

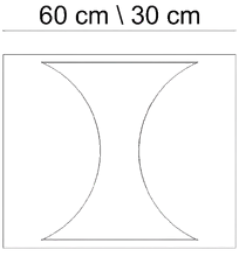

50 cm \ 25 cm

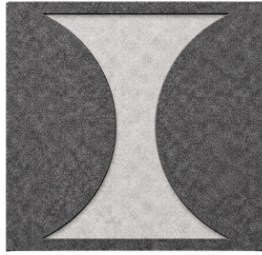

## Renk Koleksiyonu



Siyah Koyu Gri Gri Beyaz Bej



15-14f 6-16b 1-20f 4-14e 3-33c



1-11e 3-23d 4-23e 10-25e 9-21c

Malzeme :100% KEÇE

Kalınlık:6-9-12 mm

Uygulama:Yapıştırma/Modüler montaj

# GRİDA

## Modüler Panel serisi

Modüler tasarım ile sınırsız kombinasyonlar  
Akustik ve dekoratif yüzey çözümü

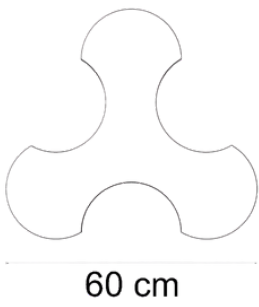
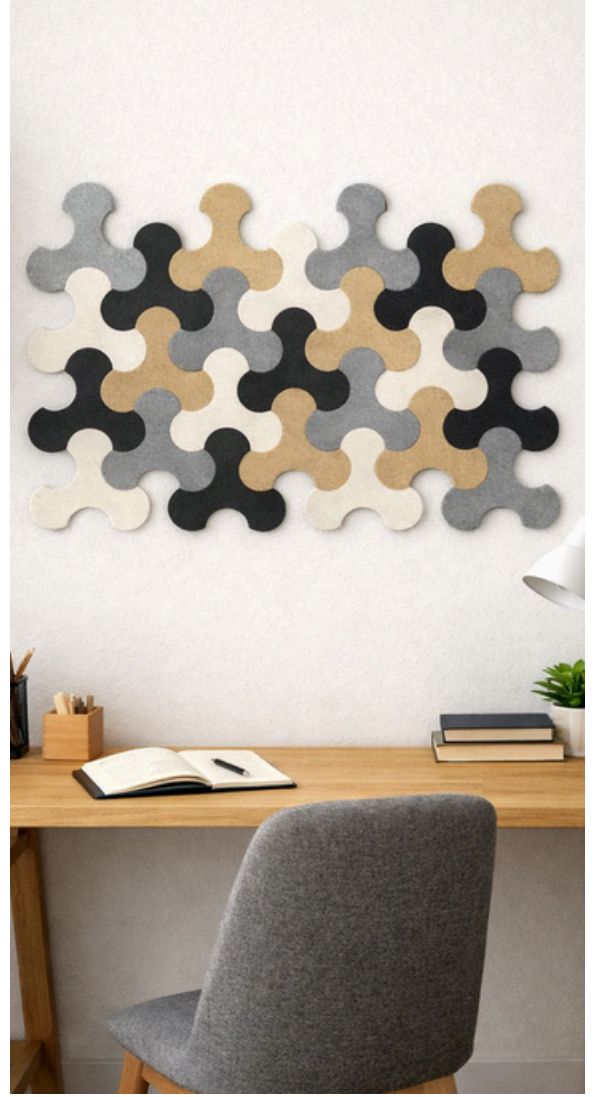

55 cm

60 cm



## Renk Koleksiyonu



Siyah Koyu Gri Gri Beyaz Bej



15-14f 6-16b 1-20f 4-14e 3-33c



1-1e 3-23d 4-23e 10-25e 9-21c

Malzeme :100% KEÇE

Kalınlık:6-9-12 mm

Uygulama:Yapıştırma/Modüler montaj

# NEVA

## Modüler Panel serisi

Modüler tasarım ile sınırsız kombinasyonlar  
Akustik ve dekoratif yüzey çözümü

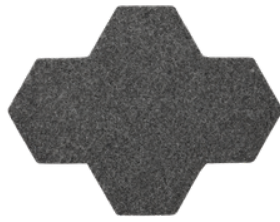
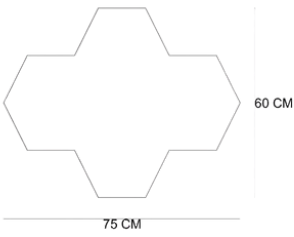

Malzeme :100% KEÇE

Kalınlık:6-9-12 mm

Uygulama:Yapıştırma/Modüler montaj

## Renk Koleksiyonu



Siyah Koyu Gri Gri Beyaz Bej

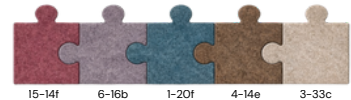

15-14f 6-16b 1-20f 4-14e 3-33c



1-1e 3-23d 4-23e 10-25e 9-21c

# FeltBi

## PUZZLE SERIES



AKUSTİK KEÇE DUVAR PANELLERİ

Sessizliđi Tasarlayın.  
Mekânlarınıza Deđer Katın.



Yüksek Ses  
Yalıtımı



Yangına  
Dayanıklı



Sürdürülebilir  
Malzeme



Uzun Ömürlü  
Kullanım

Uluslararası standartlara uygun,  
1. sınıf keçe malzeme



*FeltBi ile akustik çözümlerde  
uyum ve estetik.*

# FeltBi

# FeltBi®

## SHOWROOM / MERKEZ OFİS

Göktürk Mah. Cemal Sururi Sk. Halim Meriç İç Merkezi  
Kat: 6 No: 43, 34394, Şişli/Istanbul/Türkiye

## ÜRETİM

Bozkurt Mah. Dolapdere Cad. No.167,  
34375, Şişli/Istanbul/Türkiye

## İLETİŞİM

Bozkurt Mah. Dolapdere Cad. No: 167,  
34375, Şişli/Istanbul/Türkiye

+90 505 366 88 13

info@feltbi.com

feltbi.com

